

KOBELCO®

Your competitive edge.

Long Reach

SK210LC SK250LC SK290LC



















Dynamic Acera Hydraulic Excavator







Long Reach Attachments

Long Reach

SK210LC SK250LC SK290LC

| 40' | | 45' | | 50' | | 55' | |
|--|--|--|--|--|--|--|--|
|  |  |  |  |  |  |  |  |
| *2,400 | *2,400 | | | | | | |
| *3,510 | *3,510 | | | | | | |
| *4,270 | 3,860 | *2,140 | *2,140 | | | | |
| *4,750 | 3,690 | *3,040 | 2,780 | | | | |
| *5,050 | 3,480 | *3,680 | 2,660 | | | | |
| *5,380 | 3,270 | *4,130 | 2,530 | | | | |
| 5,350 | 3,070 | *4,320 | 2,410 | | | | |
| 5,170 | 2,900 | *4,020 | 2,310 | | | | |
| 5,060 | 2,790 | *2,820 | 2,260 | | | | |
| 5,010 | 2,750 | | | | | | |
| *4,290 | 2,810 | | | | | | |

| 40' | | 45' | | 50' | | 55' | |
|---|---|---|---|---|---|---|---|
|  |  |  |  |  |  |  |  |
| | | *1,890 | *1,890 | | | | |
| | | *2,750 | *2,750 | | | | |
| | | *3,010 | *3,010 | *2,200 | *2,200 | | |
| | | *3,150 | *3,150 | *2,870 | *2,870 | | *1,760 |
| *3,500 | *3,500 | *3,360 | *3,350 | *3,270 | *3,270 | *1,760 | *2,330 |
| *3,870 | *3,670 | *3,630 | *3,630 | *3,460 | 3,200 | *2,330 | 2,330 |
| *4,280 | *4,280 | *3,940 | 3,850 | *3,680 | 3,010 | *2,750 | 2,200 |
| *4,730 | 4,520 | *4,260 | 3,570 | *3,910 | 2,920 | *3,040 | 2,080 |
| *5,160 | 4,160 | *4,560 | 3,310 | *4,150 | 2,630 | *3,170 | 1,970 |
| *5,560 | 3,840 | *4,880 | 3,080 | *4,370 | 2,460 | *3,030 | 1,890 |
| *5,900 | 3,580 | *5,130 | 2,890 | 4,350 | 2,330 | *2,470 | |
| 6,060 | 3,390 | 5,040 | 2,750 | 4,260 | 2,225 | | |
| 5,950 | 3,290 | 4,970 | 2,690 | 4,230 | 2,220 | | |
| 5,830 | 3,270 | 4,980 | 2,700 | | | | |
| 6,010 | 3,350 | | | | | | |
| *5,410 | 3,550 | | | | | | |

| 40' | | 45' | | 50' | | 55' | |
|---|---|---|---|---|---|---|---|
|  |  |  |  |  |  |  |  |
| | | | | *1,310 | *1,310 | | |
| | | *3,400 | *3,400 | *2,240 | *2,240 | | |
| | | *3,990 | *3,990 | *2,950 | *2,950 | *1,090 | *1,090 |
| *4,600 | *4,600 | *4,290 | *4,290 | *3,570 | 3,510 | *1,840 | *1,840 |
| *5,000 | *5,000 | *4,580 | 4,310 | *4,200 | 3,270 | *2,420 | *2,420 |
| *5,450 | 5,100 | *4,900 | 3,940 | *4,490 | 3,010 | *2,870 | 2,260 |
| *5,900 | 4,590 | *5,240 | 3,570 | *4,730 | 2,750 | *3,210 | 2,070 |
| *6,340 | 4,110 | *5,560 | 3,220 | *4,970 | 2,500 | *3,370 | 1,900 |
| *6,720 | 3,710 | *5,840 | 2,920 | 4,890 | 2,280 | *3,250 | 1,760 |
| 6,840 | 3,380 | 5,650 | 2,680 | 4,710 | 2,110 | *2,670 | 1,650 |
| 6,600 | 3,160 | 5,470 | 2,510 | 4,590 | 2,000 | *1,420 | *1,420 |
| 6,470 | 3,040 | 5,390 | 2,430 | 4,560 | 1,970 | | |
| 6,460 | 3,030 | 5,400 | 2,450 | *2,200 | 2,030 | | |
| 6,570 | 3,130 | *5,430 | 2,580 | | | | |
| *5,930 | 3,390 | | | | | | |

SPECIFICATIONS SUMMARY

| | SK210LC | SK250LC | SK290LC |
|--|---------------|---------------|---------------|
| GENERAL | | | |
| Operating weight w/bucket | 50,700 lb | 59,966 lb | 74,733 lb |
| Boom weight | 4,043 lb | 5,467 lb | 7,870 lb |
| Counterweight | 12,566 lb | 15,432 lb | 16,534 lb |
| Bucket capacity range | .45-.75 cu yd | .45-.75 cu yd | .45-.75 cu yd |
| Bucket used in lift chart | 815 lb | 770 lb | 730 lb |
| Linkage and bucket used | 135SRLC | 135SRLC | SK160LC |
| ENGINE | | | |
| | Mistubishi | Mistubishi | Mistubishi |
| Make and model | 6D34-TLED | 6D34-TLA2A | 6D16-TLEG |
| Horsepower (hp/rpm) | 148@2,000 | 176@2,100 | 190@2,100 |
| WORKING RANGES | | | |
| Arm length used in lift chart | 20' 10" | 27' 1" | 26' 4" |
| Boom length used in lift chart | 28' 8" | 33' 11" | 35' 5" |
| Bucket digging force | 17,900 lb | 19,000 lb | 22,425 lb |
| Arm digging force | 11,930 lb | 11,600 lb | 12,100 lb |
| Ground level reach | 51' 7" | 60' 6" | 62' 6" |
| Max dumping height | 37' 1" | 40' 3" | 41' 2" |
| Min dumping height | 6' 4" | 5' 0" | 5' 0" |
| Digging depth | 39' 5" | 48' 6" | 49' 4" |
| Vertical wall digging depth | 36' 2" | 43' 2" | 44' 0" |
| Max digging height | 44' 10" | 47' 10" | 48' 8" |
| Max digging reach | 51' 11" | 60' 10" | 62' 10" |
| UNDERCARRIAGE | | | |
| Track overall length | 14' 7" | 15' 3" | 16' 0" |
| Track overall width with standard shoe | 10' 6" | 11' 1" | 11' 2" |
| Track shoe used in lift chart | 31.5" | 31.5" | 31.5" |
| Ground clearance | 17.7" | 17.7" | 19.7" |
| SWING | | | |
| Swing speed | 11 rpm | 11 rpm | 10 rpm |
| Min front swing radius | 15' 11" | 18' 4" | 21' 9" |
| Height at min swing radius | 34' 0" | 39' 4" | 38' 5" |
| Tail swing radius | 9' 0" | 9' 9" | 10' 1" |
| SHIPPING DIMENSIONS | | | |
| Height | 10' 0" | 9' 8" | 11' 2" |
| Width with standard shoe | 10' 6" | 11' 1" | 11' 2" |
| Length | 41' 2" | 47' 2" | 47' 10" |
| REFILL CAPACITIES | | | |
| Fuel tank | 90 gal | 90 gal | 111 gal |
| Hydraulic reservoir | 41 gal | 41 gal | 52 gal |

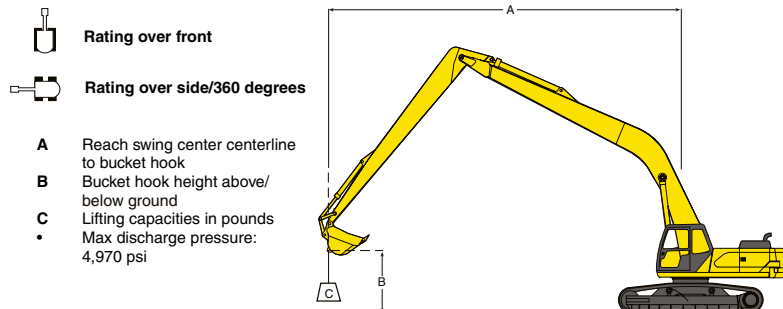

Notes:

- Do not attempt to lift or hold any load that exceeds these rated values at their specified load radii and heights.
- Lifting capacities assume a machine standing on a level, firm, and uniform supporting surface. Operator must make allowance for job conditions such as soft or uneven ground, out of level conditions, side loads, sudden stopping of loads, hazardous conditions, inexperienced personnel, weight of various other buckets, lifting slings, attachments, etc.
- Ratings at bucket lift hook.
- The previous rated loads are in compliance with SAE Hydraulic Excavator Lift Capacity Standard J 1097. They do not exceed 87% of hydraulic lifting capacity or 75% of tipping load. Rated loads marked with an asterisk (*) are limited by hydraulic capacity rather than tipping load.
- Operator should be fully acquainted with the operator's manual before operating this machine. Rules for safe operation of equipment should be followed at all times.
- Capacities apply only to the machine as originally manufactured and normally equipped by KOBELCO.

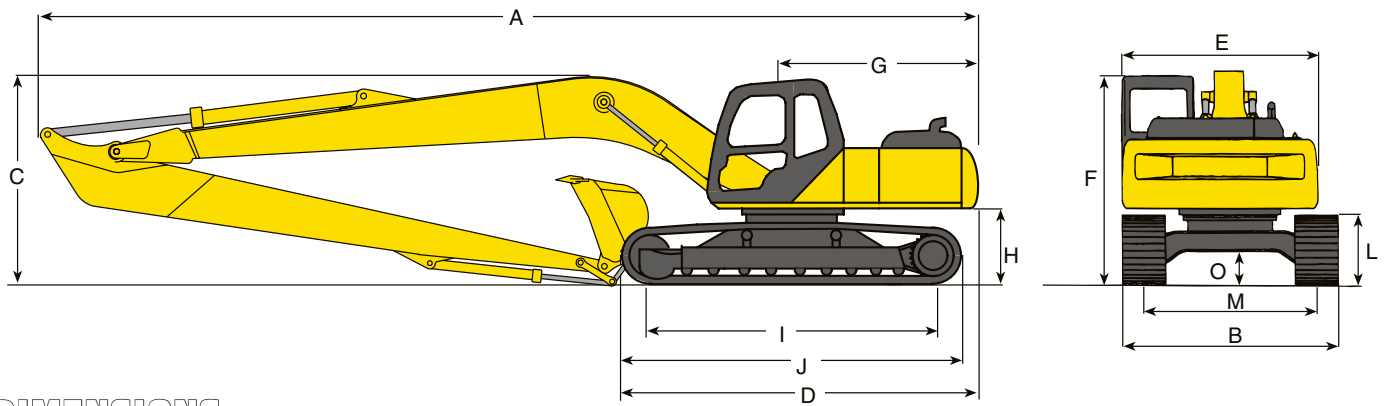

DIMENSIONS

| | SK210LC | SK250LC | SK290LC |
|--------------------------------------|---------|---------|---------|
| A Overall length | 41' 2" | 47' 2" | 47' 10" |
| B Overall width (with 800 mm shoe) | 10' 6" | 11' 1" | 11' 2" |
| C Overall height* | 10' 0" | 9' 7" | 11' 2" |
| D Basic machine length | 16' 3" | 17' 3" | 17' 11" |
| E Width of revolving upper structure | 8' 10" | 8' 11" | 9' 10" |
| F Height of cab top* | 9' 7" | 9' 7" | 10' 3" |
| G Radius of rear end | 9' 0" | 9' 9" | 10' 1" |
| H Ground clearance of rear end* | 3' 6" | 3' 5" | 3' 11" |
| I Center distance of tumbler | 12' 0" | 12' 8" | 13' 2" |
| J Overall length of crawler | 14' 7" | 15' 3" | 16' 0" |
| L Crawler height at tumbler center* | 36.8" | 38.6" | 41" |
| M Track gauge | 7' 10" | 8' 6" | 8' 6" |
| O Ground clearance of undercarriage* | 17.7" | 17.7" | 19.7" |

* Dimensions do not include height of grouser.

WORKING RANGES

| | SK210LC | SK250LC | SK290LC |
|--|---------|---------|---------|
| a Max digging reach | 51' 11" | 60' 10" | 62' 10" |
| a ¹ Max digging reach at ground level | 51' 7" | 60' 6" | 62' 6" |
| b Max digging depth* | 39' 5" | 48' 6" | 49' 4" |
| c Max digging height* | 44' 10" | 47' 10" | 48' 8" |
| d Max dumping clearance* | 37' 1" | 40' 3" | 41' 2" |
| e Min dumping clearance* | 6' 4" | 5' 0" | 5' 0" |
| f Vertical wall digging depth | 36' 2" | 43' 2" | 44' 0" |
| g Min swing radius | 15' 11" | 18' 4" | 21' 9" |
| h Height at min swing radius* | 34' 0" | 39' 4" | 38' 5" |

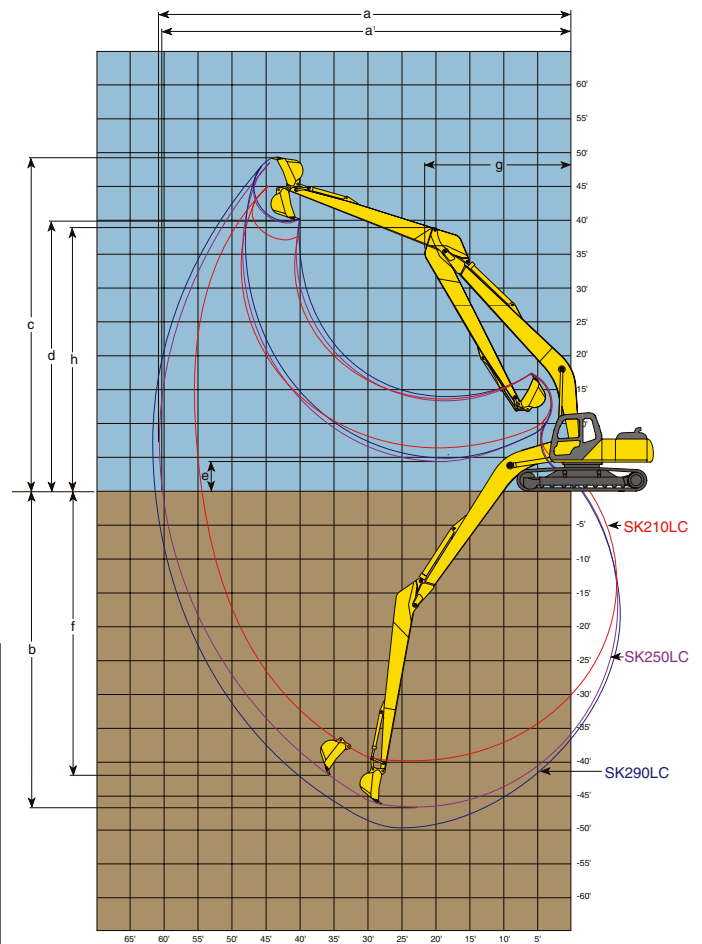

NOTE: Illustration shows SK250LC with SK210LC & SK290LC working ranges superimposed around it.

KOBELCO®

Your competitive edge.

Kobelco Construction Machinery America LLC

245 E. North Avenue
 Carol Stream, IL 60188-2021
 866-726-3396 Toll Free
 630-260-4000
 630-260-4304 Fax

E-mail: digin@kobelcoamerica.com
 Website: www.kobelcoamerica.com

NOTE: Due to our policy of continual product improvement, all designs and specifications are subject to change without advance notice.

Long Reach

SK210LC SK250LC SK290LC